

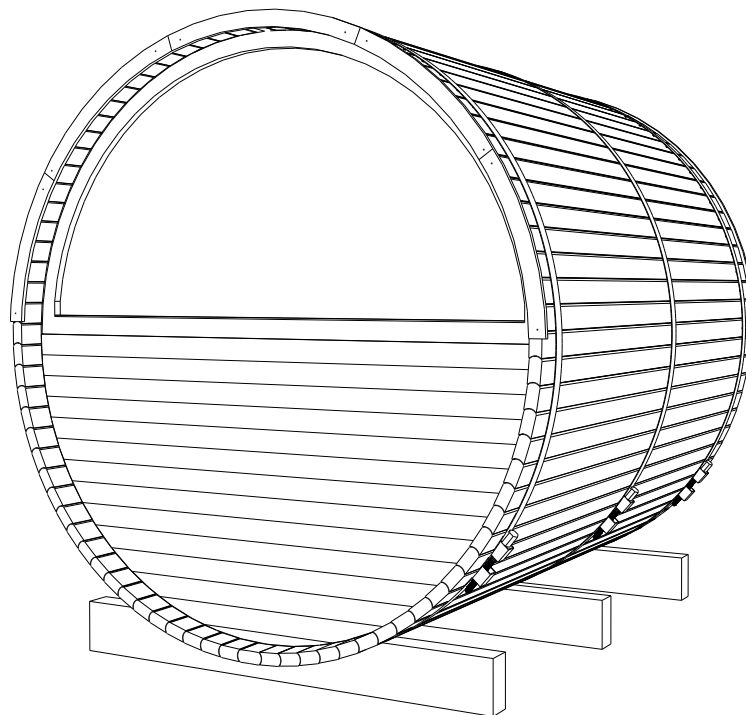

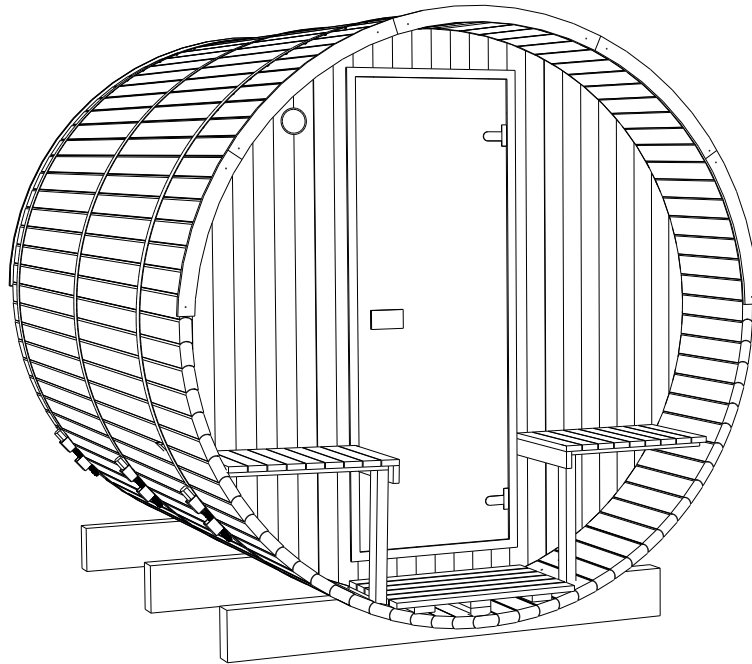



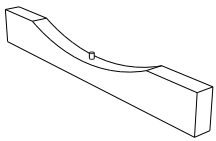
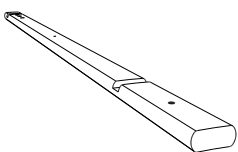
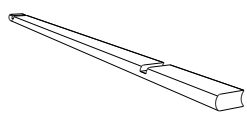
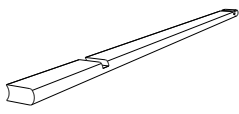
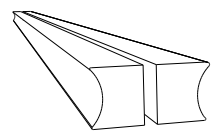
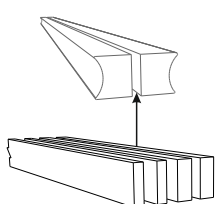
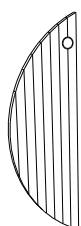
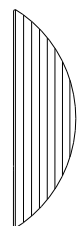

# HEKLA

## BARREL SAUNA 250 ASSEMBLY INSTRUCTION

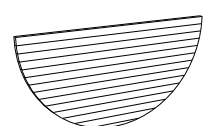
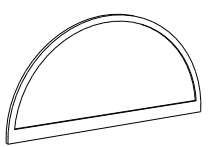
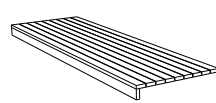
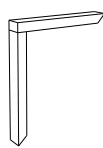
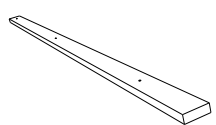

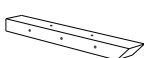

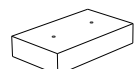
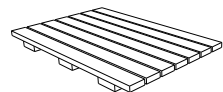
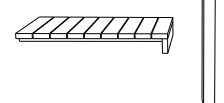
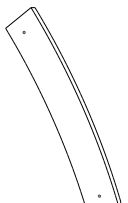
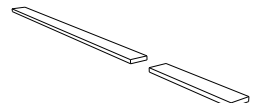
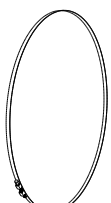

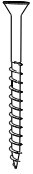

MODEL: RTP-229-250

**PART LIST**

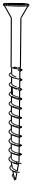
<p><b>A</b> x3</p> 	<p><b>B</b> x1</p> 	<p><b>C</b> x40</p> 	<p><b>C1</b> x40</p> 	<p><b>H</b> x2</p> 
cradle	center stave	left side body stave	right side body stave	final H type stave at the top
<p><b>H1</b> x4</p> 	<p><b>F</b> x1</p> 	<p><b>F1</b> x1</p> 	<p><b>F2</b> x1</p> 	<p><b>V</b> x1</p> 
different thickness filling peaces	left panel section	right panel section	door panel	bottom rear panel
<p><b>V1</b> x1</p> 	<p><b>J</b> x2</p> 	<p><b>J1</b> x2</p> 	<p><b>J2</b> x6</p> 	<p><b>J3</b> x2</p> 
rear panel with panoramic window	sauna bench	supporting leg	backrest stave	wall mount
<p><b>J4</b> x2</p> 	<p><b>L</b> x2</p> 	<p><b>L1</b> x6</p> 	<p><b>L2</b> x1</p> 	<p><b>K</b> x2</p> 
wall mount	flooring duckboard	fixing block for flooring duckboard	flooring duckboard (outside)	benches
<p><b>W</b> x10</p> 	<p><b>O</b> x1</p> 	<p><b>I</b> x3</p> 	<p><b>D</b> x3</p> 	<p><b>S1</b> x35</p> 
decorative roof finishing board	aspen roof board	metal band	wooden cable raceway kit	screw 5.0x100 SS

**PART LIST**

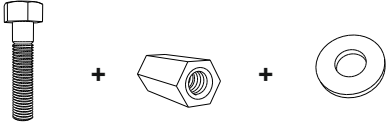
<p><b>S1</b> x50</p> 	<p><b>S2</b> x100</p> 	<p><b>S3</b> x40</p> 	<p><b>S4</b> x8</p> 	<p><b>S5</b> x40</p> 	
screw 5.0x100 SS	screw 4.0x70	screw 4.0x50	screw 5.0x120	screw 4.0x50 SS	
<p><b>S6</b> x45</p> 	<p><b>S7</b> x25</p> 	<p><b>S8</b> x15</p> 	<p><b>S9</b> x3 + x3 + x6</p> 		
screw 5.0x70 SS	screw 4.2x55 brown	wire raceway nails	bolt ø16x140	hex nut M16 (SW24)	flat washer

PO- \_\_\_\_\_

\_\_\_\_\_

\_\_\_\_\_

Signature

**BARREL DIMENSIONS**

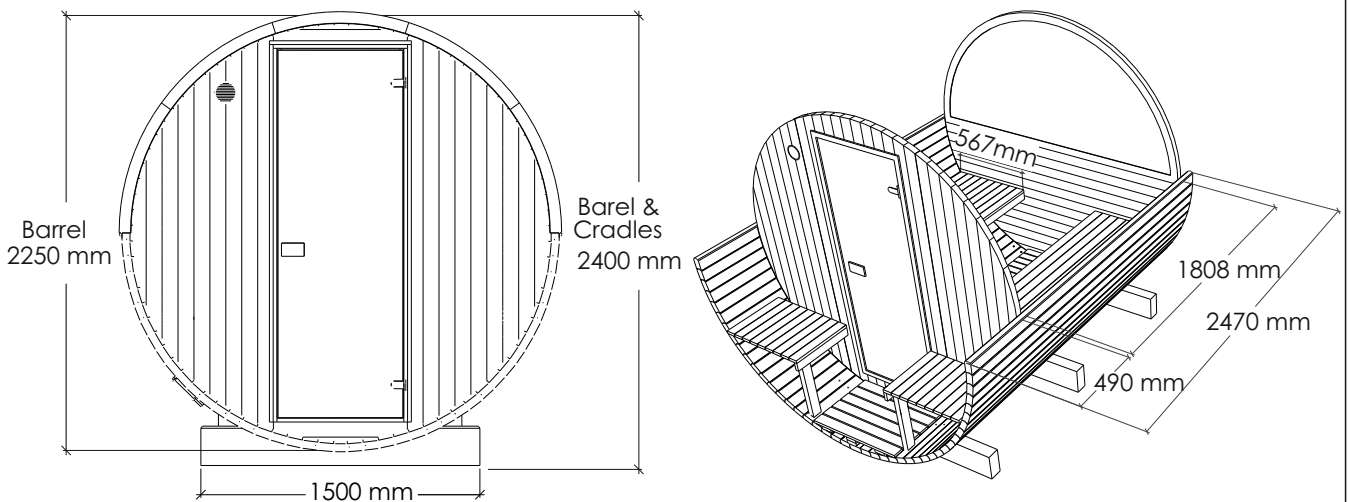

**RECOMMENDATION**



2 person recommended

**TOOLS REQUIRED**



**STEP 1:** Measure support cradles (A) diagonally from corner to corner. Measurements "a" and "b" should be equal to ensure the cradles are square. Be sure cradles remain level.

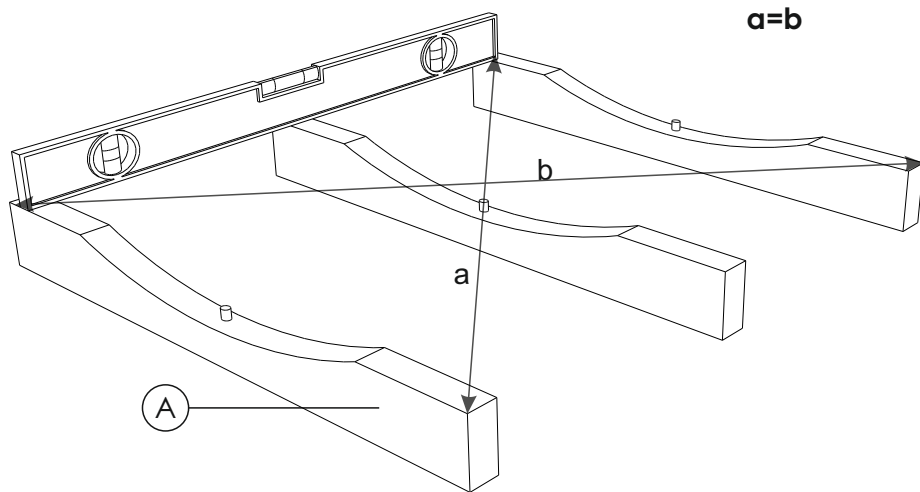

**STEP 2:** Place the support cradles (A) on level site. The middle support cradle will have no dowel. Carefully level for better stability. Place the center stave (B) on wooden dowels embedded in outer support cradles (A). Fix the center stave (B) with 5.0x100 SS(S1).

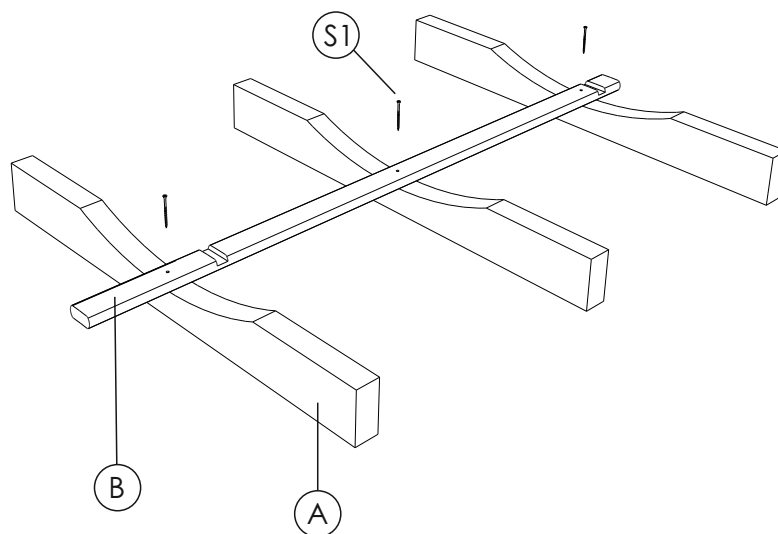

**STEP 3:** Place 6 sauna body staves (C) to each side of the center stave (B) and fix with screws 5.0x100 SS (S1). Be sure to align the panel groove on every next body stave.

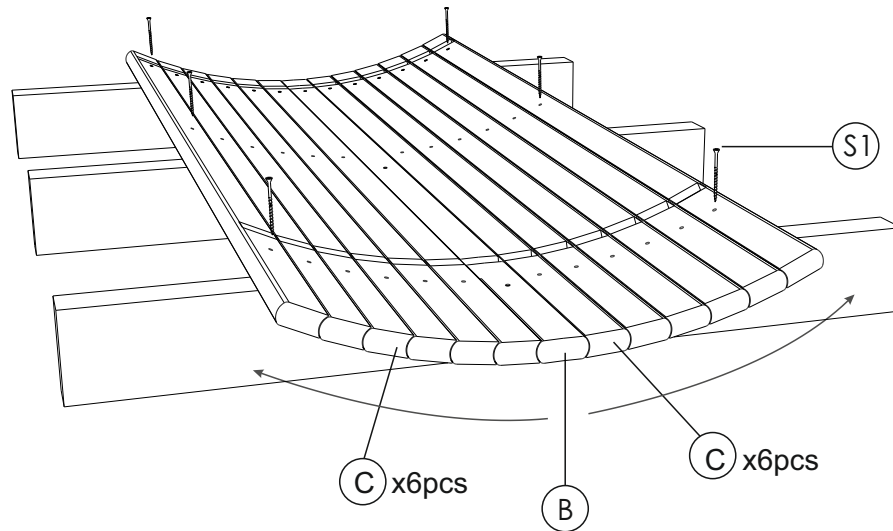

**STEP 4:** Place door panel (F2) in front slot. Be sure panel is centered, leveled, completely seated. Attach side panels (F, F1) using 4 5.0 x 120 (S4) screws. Place rear panel (V) with bench supports facing interior. Confirm width of rear panel (V) matches combined width of left panel section (F), front panel (F2) and right panel section (F1). These panels must be completely seated into the floor panel.

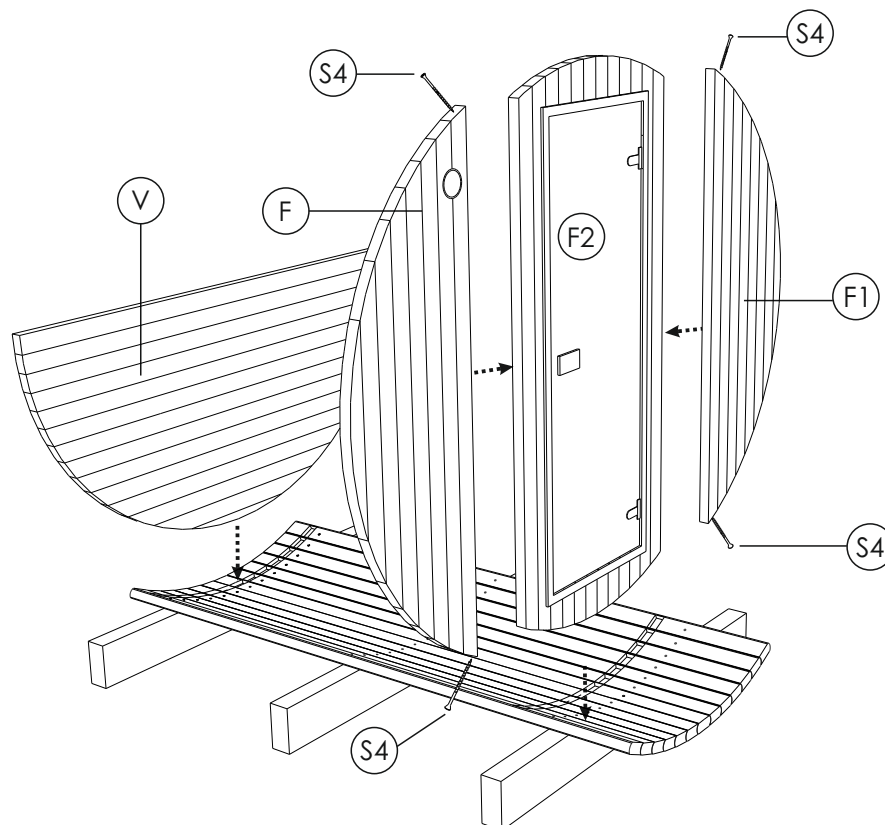

**STEP 5:** Place body staves (C,C1) until the halfway point. Place rear panel with panoramic window (V1) on bottom rear panel (V), fix by 2 screws 5.0 x 120 (S4). Bind panels (F2; V1) together by temporarily placing one or two body stave (C) on top of them.

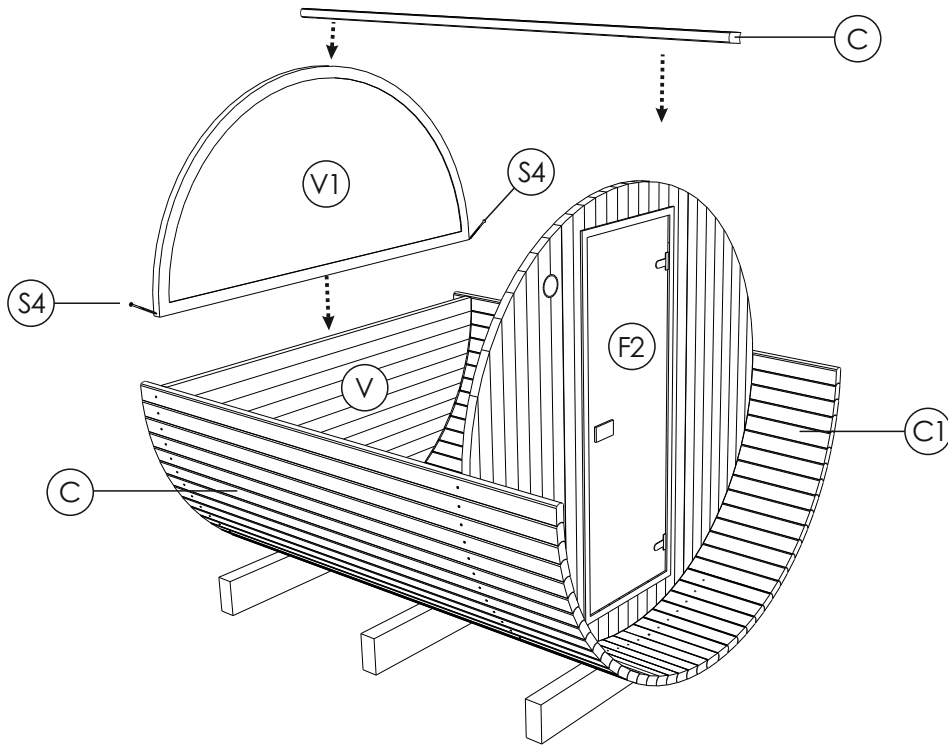

**STEP 6:** Continue placing body staves (C,C1) tightly on both sides of the sauna using rubber mallet, while fixing body staves on the front panel with screws 4.20x70(S2) and rear window panel (V1) with 4.0 x 50 screws (S3) to prevent glass breakage. To finish the roof top joint, use roof finishing item (H). Different thickness filling peaces (H1) are provided to completely fill the gap.

**WARNING!**  
Use shorter screw 4.0 x 50 (S3)  
for rear panel V1 otherwise  
the window will be damaged!

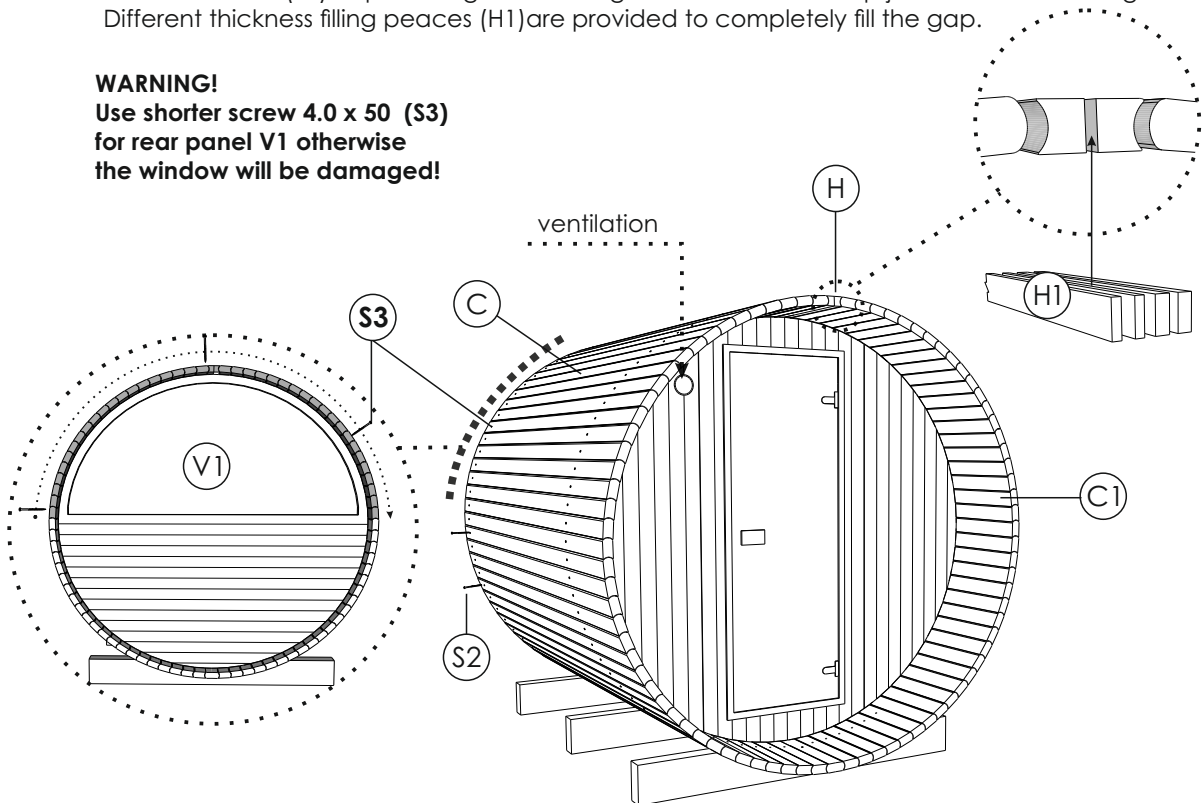

**STEP 7:** Measure steel bands (I) to ensure correct length of 500mm is acceptable. Install steel bands (I) by wrapping bands around barrel prior to connecting with bolts and nuts (S9). Place steel bands evenly around barrel, covering screw heads. Measure from steel band to barrel edge to ensure the steel band is even. Install interior aspen roof trim (O) with 4.0 x 50 SS (S5) screws.

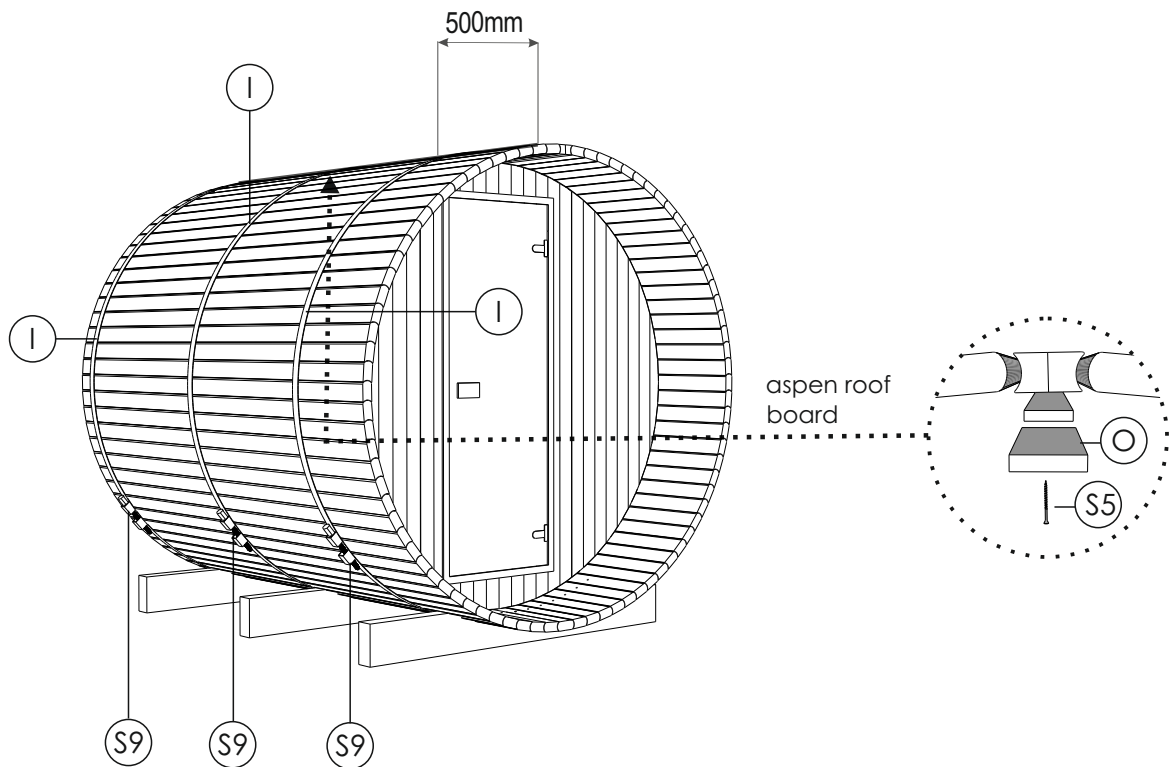

**STEP 8:** Install wall mounts (J3, J4) using screw 5.0x70 SS (S6). Attach interior supporting leg (J1) to the bench (J) using screw 5.0 x 70 SS (S6). Install two sauna benches on wall mounts using screw 5.0 x 70 SS (S6). Hold the seat and leg assembly tight to the sauna wall. Using a level, make sure the bench seat is level from front to back. This will ensure proper placement. Install backrests (J2) at your chosen height using screw 4.0 x 50 SS (S5).

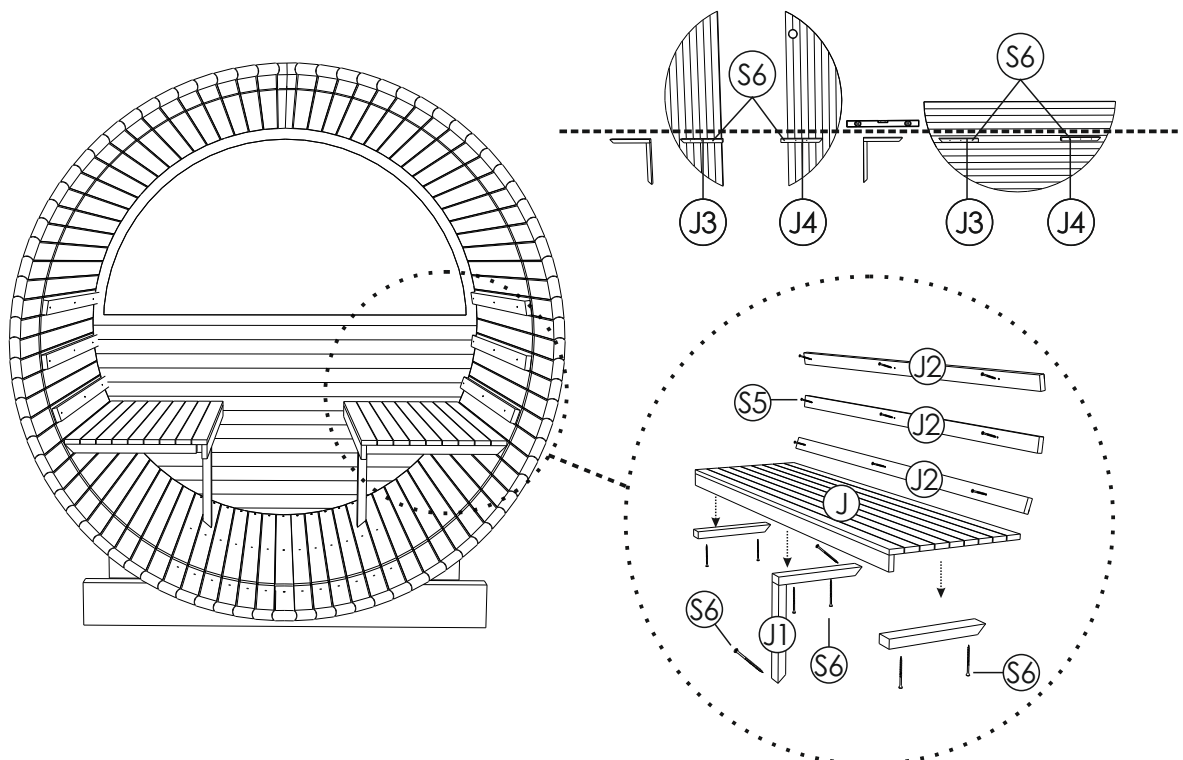

**STEP 9:** Install fixing blocks (L1) under floor duckboard. Place floor duckboards (L).

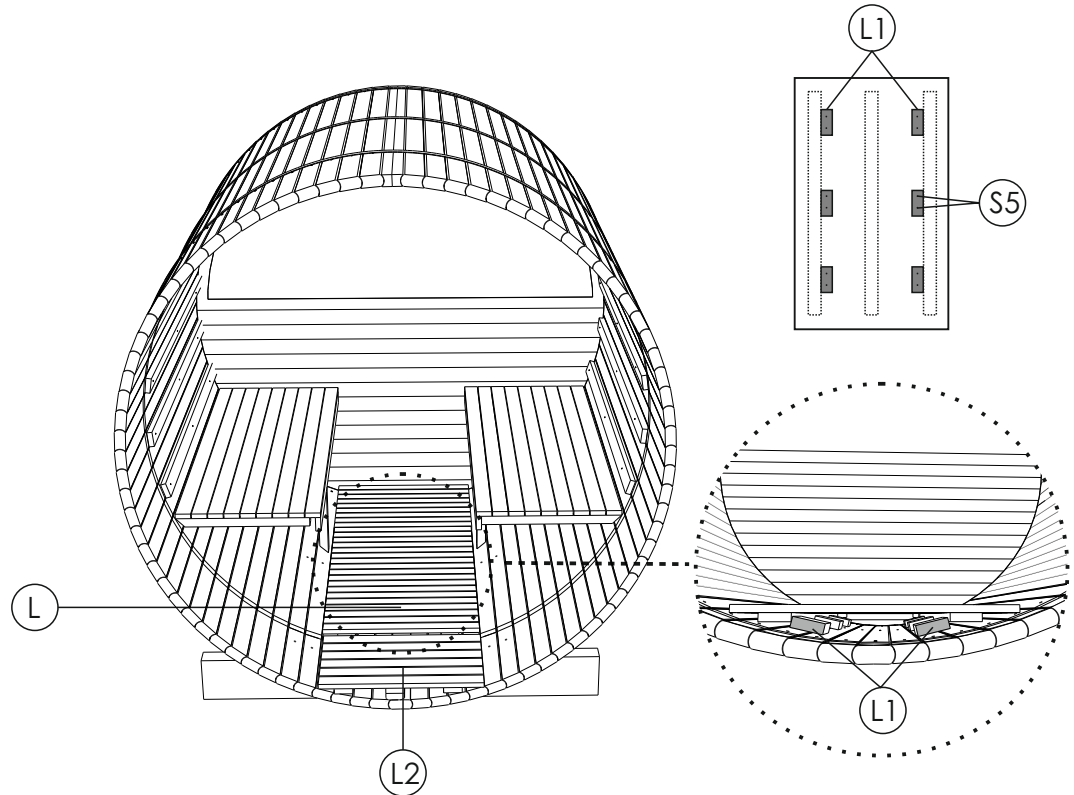

**STEP 10:** Install front and rear decorative roof finishing boards (W), fixing by screws 4.2x55(S7). Install porch benches (K), using screws 5.0 x 70 SS (S6) and 5.0 x 100 SS (S1). Hold the seat and leg assembly tight to the sauna wall. Using a level, make sure the bench seat is level from front to back. This will ensure proper placement.

