



# OWNER'S MANUAL



## SUN & SOUL® FAR INFRARED SAUNAS

Please read this manual before using your sauna for the first time.  
Please keep this manual for future reference.



# Table of Contents

Welcome .....	03
Installation .....	04
<b>01   SUN &amp; SOUL MODELS 1, 2 AND 3 .....</b>	<b>05</b>
Using Your Sauna Control Panel .....	22

# Installation

## Choosing a location

Place your sauna on a dry and level surface for best results. Garage, basement, attic, playroom, bedroom, or garden house are just a few of the possible locations for your sauna.

Your sauna's natural exterior will beautifully complement any location.

Installation requirements for your sauna are as follows:

1. Your Sun and Soul sauna is a self-contained and freestanding unit. It should not be built into any structure without prior authorisation.
2. Please maintain a minimum of 8cm / 3.25" clearance on all sides of the unit to allow air to circulate while giving access for the power cord..

## Cleaning and maintenance

1. Before using your sauna for the first time, clean the inside of the sauna with a damp cloth. Use your favorite furniture polish on the exterior.
2. Place a towel on the floor and bench to absorb any perspiration. Wash these often to maintain a clean and pleasant environment inside your sauna.
3. Perspiration may darken the wood over time. This can be removed by a light sanding with fine grit sandpaper.



Please be careful when carrying and installing the glass pieces to avoid breakage. Make sure the glass is securely fastened during installation before letting go of any individual piece that could break.

**01**

# **SUN100, SUN200 AND SUN300**

FS Packaging - - - - -	06
Assembly Instructions - - - - -	07

# FS Packaging

## CONTENTS OF BOXES

### Box 1 of 3

1. Floor Panel
2. Ceiling Panel
3. Accessories
4. Install Manual

### Box 2 of 3

1. Left Side Wall
2. Right Side Wall

### Box 3 of 3

1. Front Wall
2. Back Wall
3. Bench & Bench Support

## ACCESSORY BOX CONTENTS

Door Handle



Double eye brackets (3)  
Mounting screws (6)

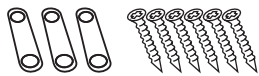

Front heater mounting  
bolts (12 sets)



Front heater mounting  
brackets (4 sets)

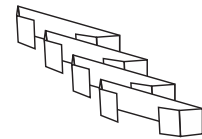

6 Magnetic Strips



# Assembly Instructions

Assembly of the sauna requires a minimum of two adults to complete. As noted, a third person is recommended when installing the glass components. Please read the instructions thoroughly before and during assembly to ensure proper installation of the unit. Wearing booties to cover your shoes will protect the wood from getting scuffed or stained.

## 1 - LOCATION OF SAUNA & INSTALLATION ORDER

When determining a location for your sauna, please keep in mind the following:

1. The main power cord on the sauna must be easily accessible.
2. The location must be dry and level.
3. Panels should be installed in the following order:
 

1) Floor	4) Right Side Wall	7) Front Wall
2) Back Wall	5) Under Bench Support	8) Roof
3) Left Side Wall	6) Bench	

## 2 - PLACING FLOOR PANEL

1. Place the bottom floor panel on the ground near the location you will using the sauna. Make sure the front of the floor is in the desired location of the door.

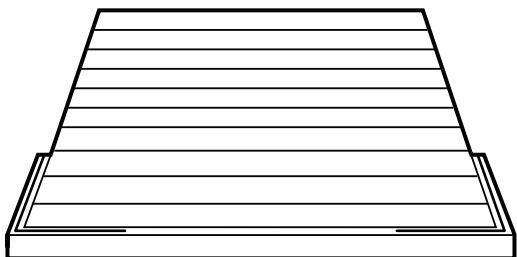

## 3 - CONNECTING THE BACK PANEL TO THE FLOOR PANEL

1. Place the back panel on the floor panel by lining up the back panel on the groove of the floor panel.

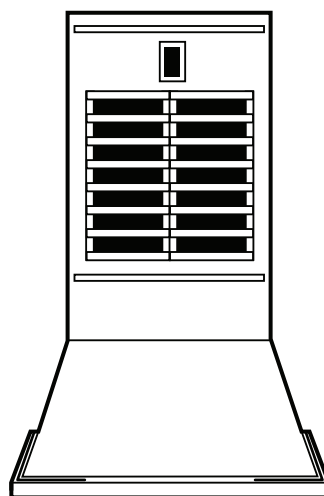

# Assembly Instructions Cont'd

## 4 - CONNECTING SIDE WALLS

The side wall panels will be connected to the back wall by connecting together the installed brackets. There are "+" brackets and "-" brackets on the side of each panel. The side walls will be installed as follows:

1. Place the left side wall in the slot in the floor. Lift the side wall up about 4" (10cm) higher than the backwall panel (See Picture 1).
2. Place the side wall panel against the back wall (See Picture 2), then slide down side wall panel until the two panels are equal height. (See Picture 3).
3. If the panels are not equal height or there is an obvious gap between the two panels, this means they are not properly attached and you should try again. The panels will not stand in place on their own, so hold them up to do this assesment.
4. Repeat the steps above for the right side wall panel.

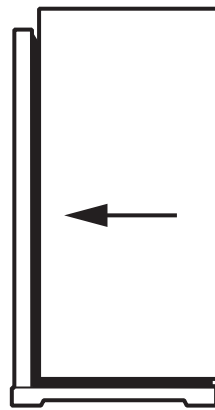

Picture 1

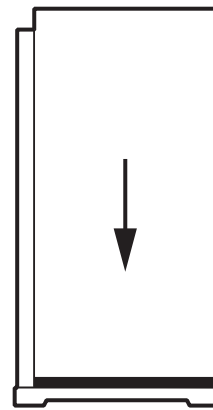

Picture 2

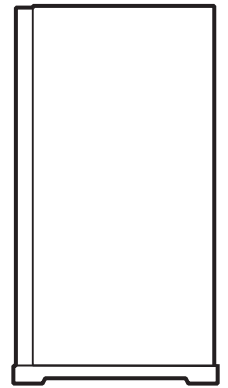

Picture 3



If the panels still seem too tight to come down all the way, try backing off the bracket screws by one half turn with a Phillips head screwdriver on the female bracket.

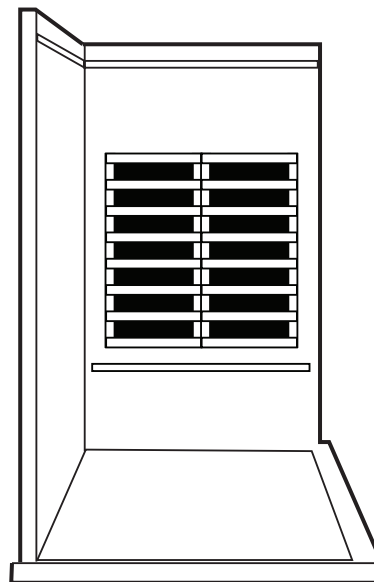

Left Side Wall Installed

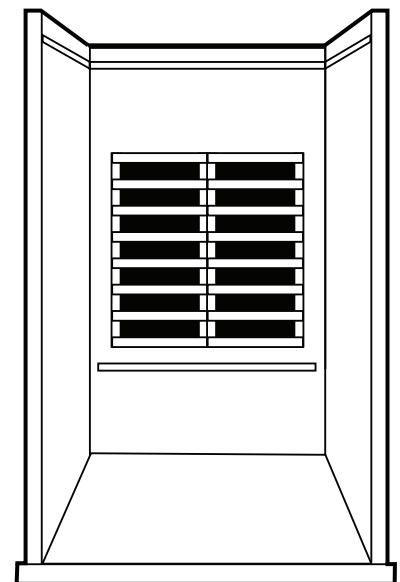

Right Side Wall Installed



# Assembly Instructions Cont'd

## 5 - INSTALLING FLOOR MOLDING

1. Locate the two short and one long floor molding pieces.
2. Using a Phillips head screwdriver screw in the floor molding pieces.
3. The short pieces are screwed in along the short left and right side wall pieces. The long piece is screwed in along the back.

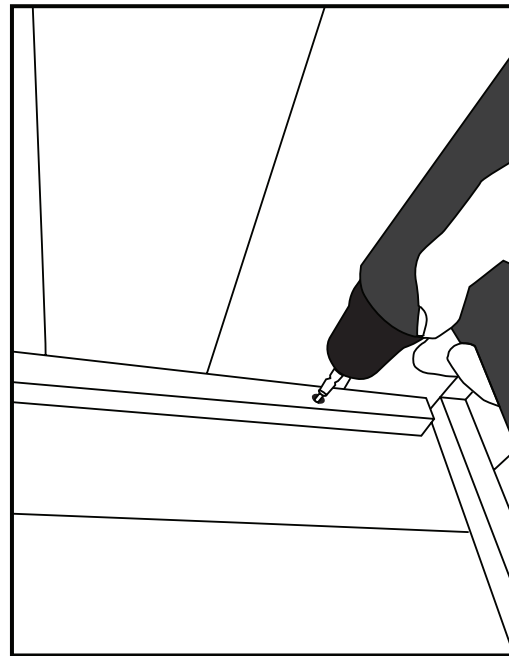
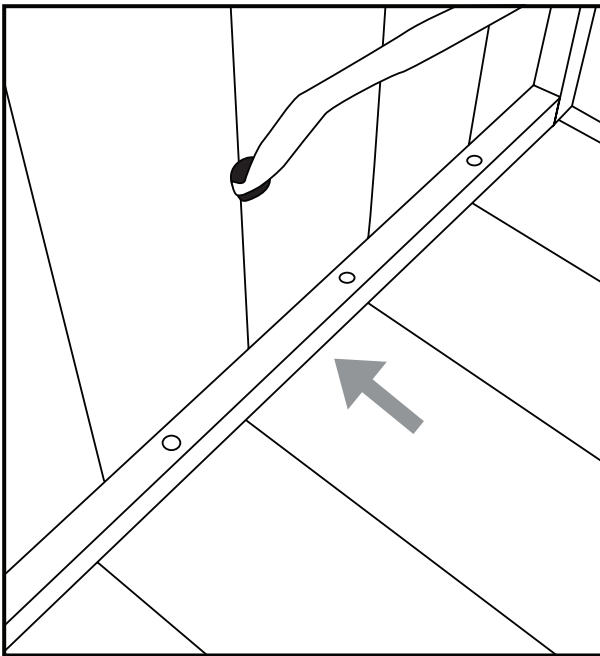

# Assembly Instructions Cont'd

## 6 - INSTALLING UNDER BENCH SUPPORT

Slide down the bench heater panel by lining up its sides with the vertical guides on the left and right side wall panel.

1. Be careful not to scratch the side panels when positioning the heater panel.
2. Push the bench heater panel all the way down until it is touching the floor panel and is securely in place.

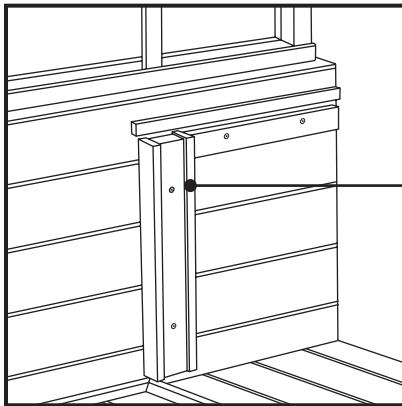

Vertical bench heater panel guides are found on the side panels.

Heater must be facing outward

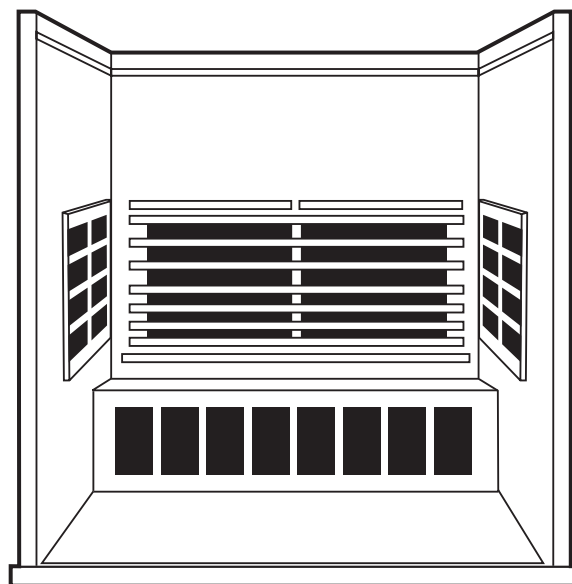
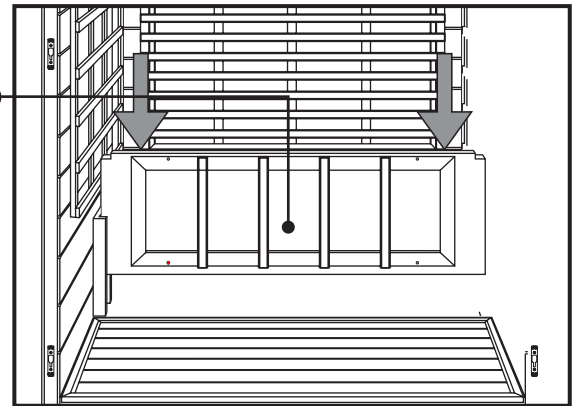

# Assembly Instructions Cont'd

## 7 - CONNECT HEATER CONNECTION UNDER BENCH

Follow the connections as in the following illustration:

1. Connect the black and white cable coming out of the back of the under bench support to one of the left side wall connectors.
2. Connect the side black and white wall cable to one of the floor connectors.
3. Connect the black and white back wall cable to the other floor connector.
4. Connect the green ground connectors together.



You can plug any male connector to any female one as long as the colors match.

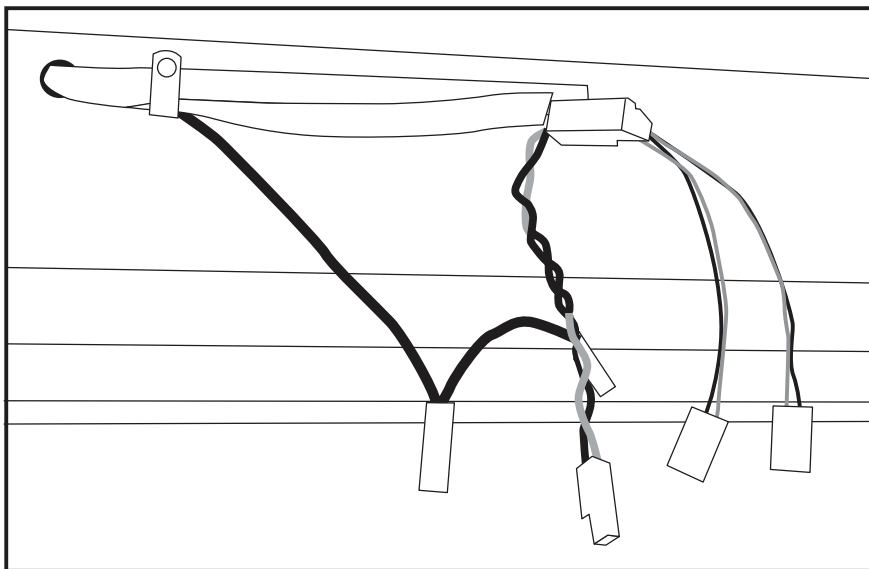
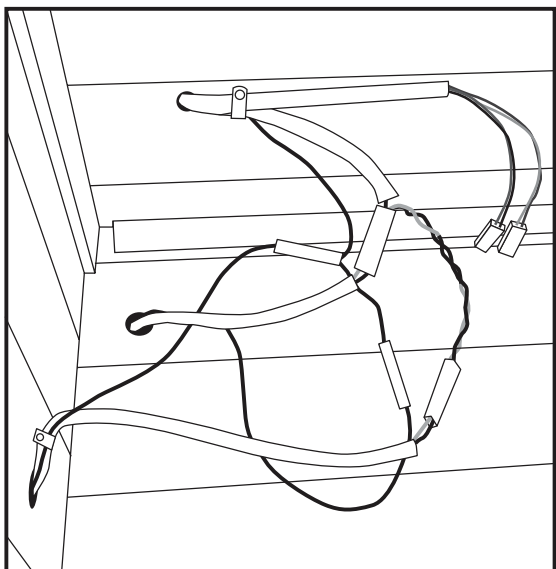

# Assembly Instructions Cont'd

## 8 - INSTALLING THE BENCH

Install the bench by sliding it over the horizontal bench guides on the side panels. Be careful not to scratch the adjacent panels when sliding in the bench.

Push the bench all the way in until it touches the back panel and is securely in place.

The bench is reversible. One side is ergonomic and one side is flat. You can reverse the bench after the sauna installation is finished. **Be sure that the bench is pushed all the way back until it slides under the heater guard to secure the bench in place.**

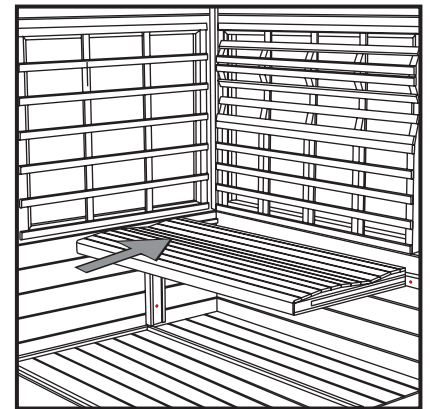
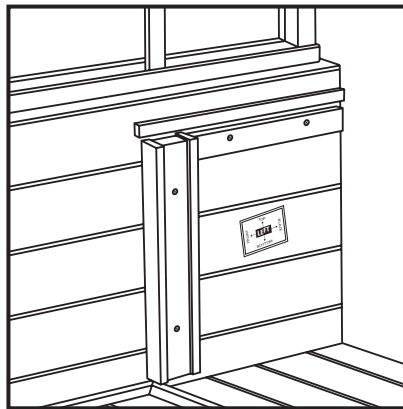
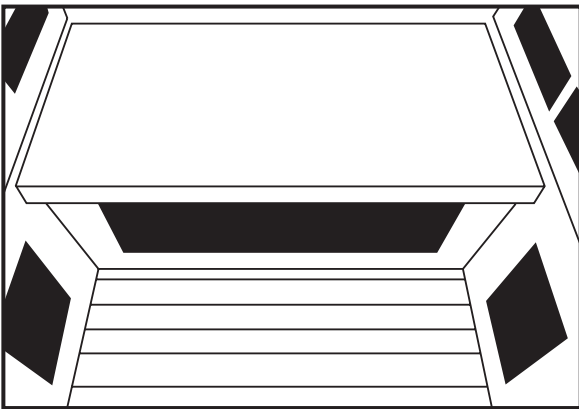

# Assembly Instructions Cont'd

## 9 - INSTALLING THE ROOF PANEL

Before you begin the assembly of the roof, expose the heater cables that you will need to connect through the “trap door” in assembly step 13.

1. Lower the roof panel on to the assembled panels.
2. Position the top panel so that the exterior lights are at the front of the sauna.
3. Make sure that the cables from the top panel do not get pinched when placing the panel.
4. Gently place the top panel onto the rest of the assembled panels. When all four corners are in place, gently push down the roof panel from the outside corners until it fits snugly over the rest of the panels.

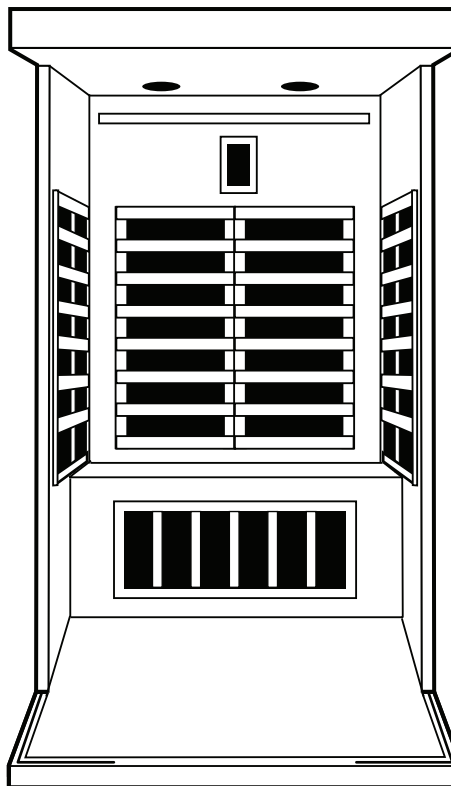
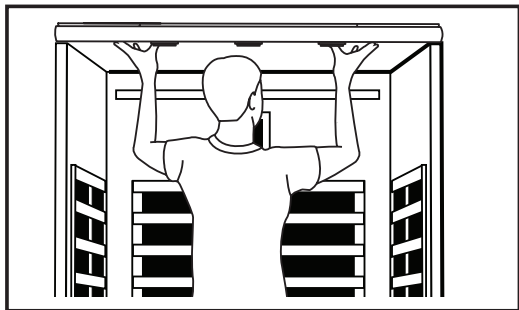

# Assembly Instructions Cont'd

## 10 - INSTALLING THE SIDE WALL GLASS

When installing the glass panels, a third person is recommended to support the glass during installation.

1. Locate the left side wall glass.
2. Align the side wall glass in the slot on the floor next to the left side wood wall.
3. Slide the glass into the slot.
4. Lift up the roof at the front left corner about 2in/5cm, align the glass under the slot in the roof and then push the roof down on the glass.
5. Repeat this step for the right side wall glass.

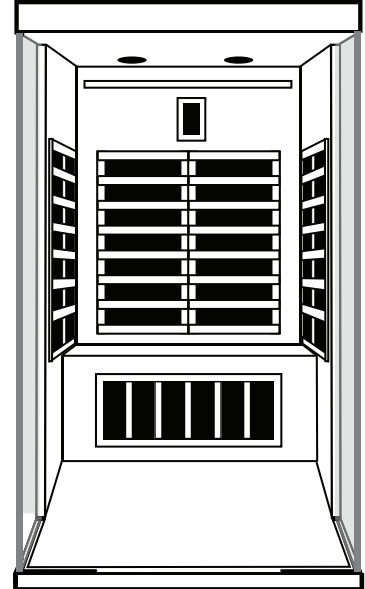
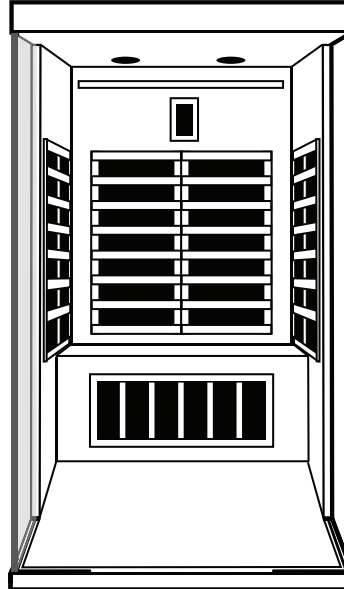
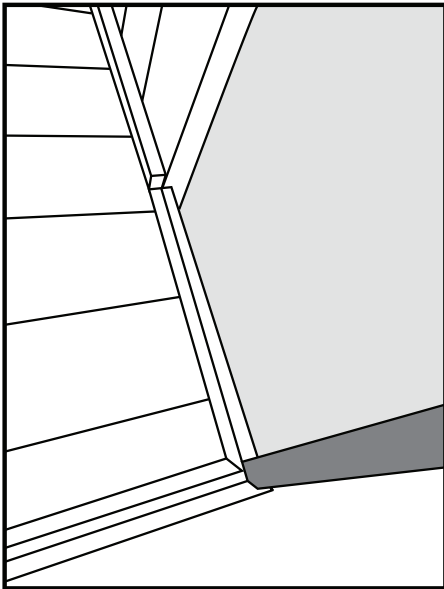

# Assembly Instructions Cont'd

## 11 - INSTALLING THE FRONT GLASS

When installing the glass panels, a third person is recommended to support the glass during installation.

### Left Front Wall Glass

1. Locate the left front wall glass.
2. Align the left front glass in the slot in the floor.
3. Slide the glass into the slot.
4. Lift up the roof at the front left corner about 2in/5cm, align the glass under the slot in the roof and then push the roof down on the glass.

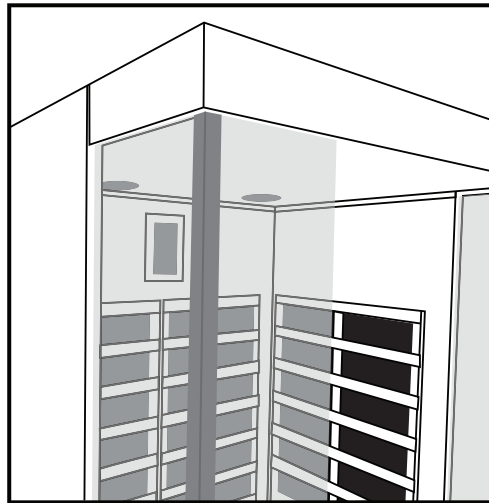
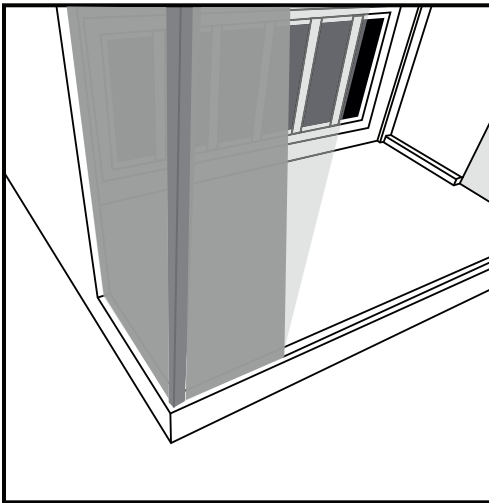

# Assembly Instructions Cont'd

## 11 - INSTALLING THE FRONT GLASS

When installing the glass panels, a third person is recommended to support the glass during installation.

### Right Front Wall Glass

1. Locate the door and right side glass.
2. Align the right front glass in the slot in the floor.
3. Slide the glass into the slot. Be sure to have someone hold the door while you put the right side glass in the slot.
4. Lift up the roof at the front left corner about 2in/5cm, align the glass under the slot in the roof and then push the roof down on the glass.
5. Attach the magnetic strips to the edges of the glass by pushing them on. Note that the magnetic portion of the strip that is placed on the side walls should be facing the strip which is attached to the front wall.

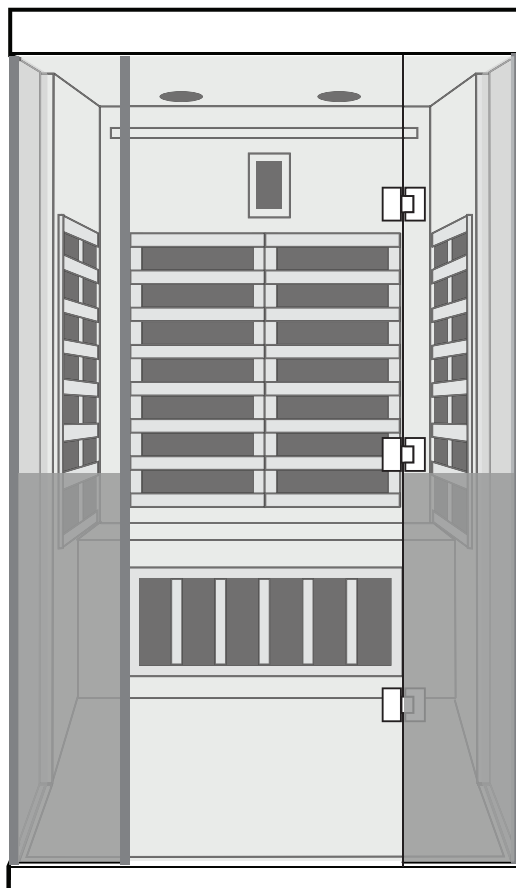



# Assembly Instructions Cont'd

## 12 - INSTALLING ROOF BRACKETS

1. Locate the three double eye roof brackets and 6 screws.
2. Install the first double eye roof bracket in the top of the roof above where the left side glass meets the left side wood wall by screwing it in to join the two sections.

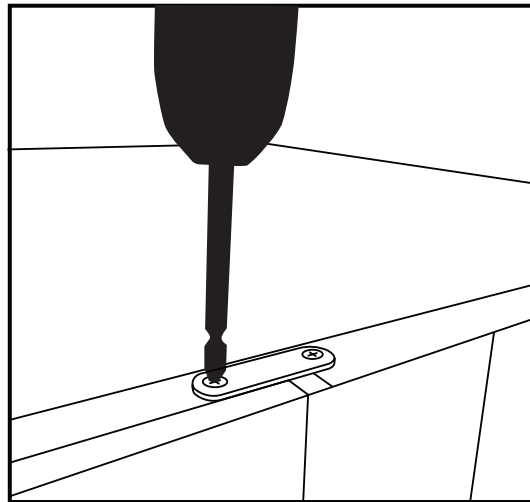
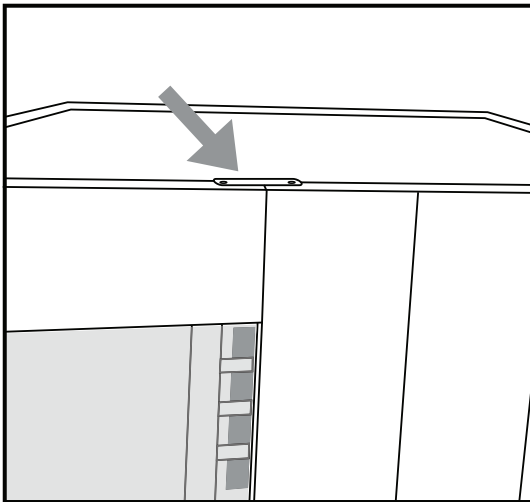

# Assembly Instructions Cont'd

## 12 - INSTALLING ROOF BRACKETS

3. Repeat this for the right side.
4. The third double eye bracket connects the back wall to the roof cover.
5. Align the bracket in the centre of the back wall and screw in one side to the top of the back wall section and the other side to the roof dust cover.

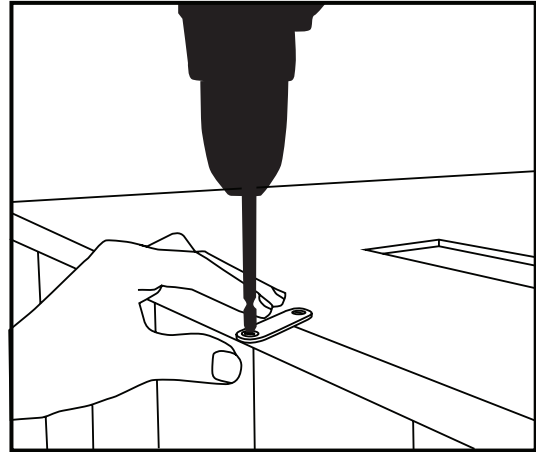

## 13 - CONNECT HEATERS IN ROOF

1. Locate the "trap" doors that open in the roof.
2. Connect the black and white cables that come out of the walls to the connector located in the roof.
3. Connect the green ground wire that comes out of the walls to the green ground wire that is in the roof. Push the wiring inside the roof area and close the roof door compartments.
4. In the left side wall compartment, there will be two connectors: 1) Heater connector. 2) Keypad connector. The heater connector is a two wire connector. The keypad connector is a seven wire connector.

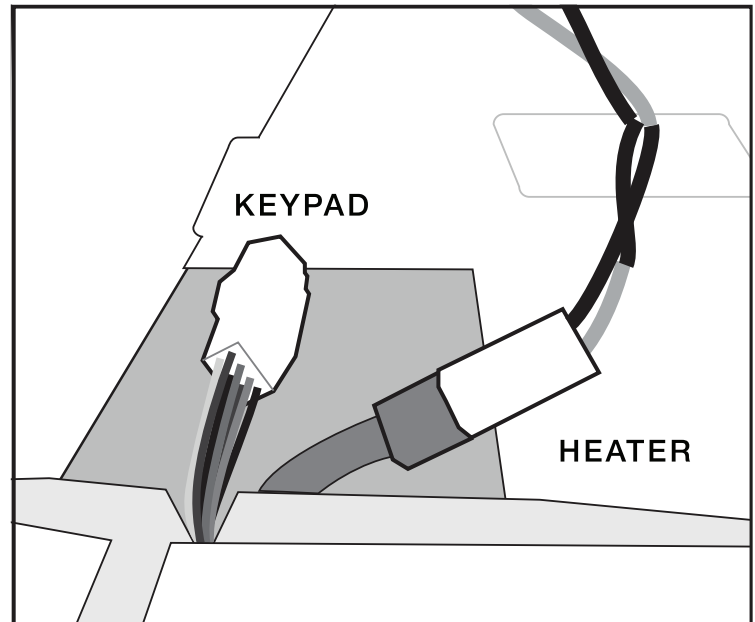

**BE SURE TO MATCH THE COLORS IN THE CONNECTORS.  
THE BLACK WIRE SHOULD MATCH UP WITH THE BLACK WIRE, ETC.**

# Assembly Instructions Cont'd

## 14 - INSTALLING DOOR HANDLE

1. Locate the door handle.
2. Attach the door handle using the enclosed bolts.  
Be careful not to overtighten the bolts as this may damage the glass.



## 15 - ATTACHING THE FRONT HEATERS

1. Attach the corner brackets to each heater with the bolts provided.
2. Place the heater in the front corner of the sauna and connect the cable.
3. Screw the bolts through the glass holes into the heater brackets
- 4 Repeat for the other side

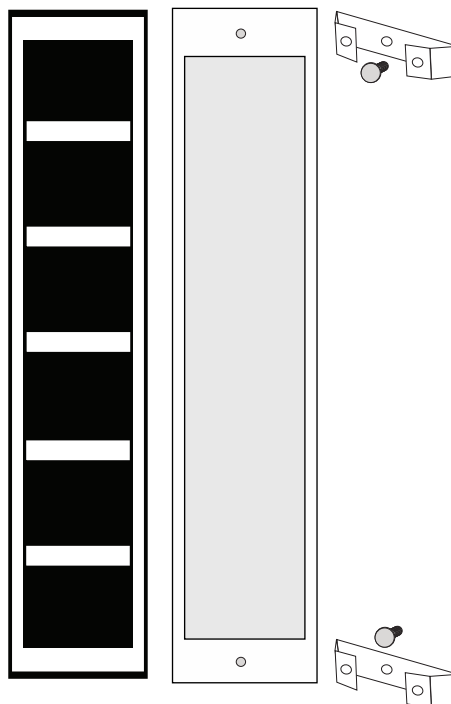

# Assembly Instructions Cont'd

## 15 - LOCATING AND PLUGGING IN POWER CORD

The power cord comes out of the roof of the sauna. If you are standing facing the sauna, it comes out of the rear left corner of the roof. Open the trap door to access the power cord and run the cord down the back of the sauna. The power cord will plug into the appropriate electrical receptacle.



**Note:** We do not recommend using an extension cord for your sauna. Please plug the sauna directly into the wall receptacle.

## 15 - LOCATING AND PLUGGING IN POWER CORD

The power cord comes out of the roof of the sauna. If you are standing facing the sauna, it comes out of the rear left corner of the roof. Open the trap door to access the power cord and run the cord down the back of the sauna. The power cord will plug into the appropriate electrical receptacle.



**Note:** We do not recommend using an extension cord for your sauna. Please plug the sauna directly into the wall receptacle.

# Assembly Instructions Cont'd

## 16 - INSTALLATION IS COMPLETE

Installation of your sauna is now complete. Using a damp cloth, wipe out the sauna to remove any excess saw dust that may have settled on the wall & floor panels and the heater panels.

Please refer to usage instructions located later on in this manual.

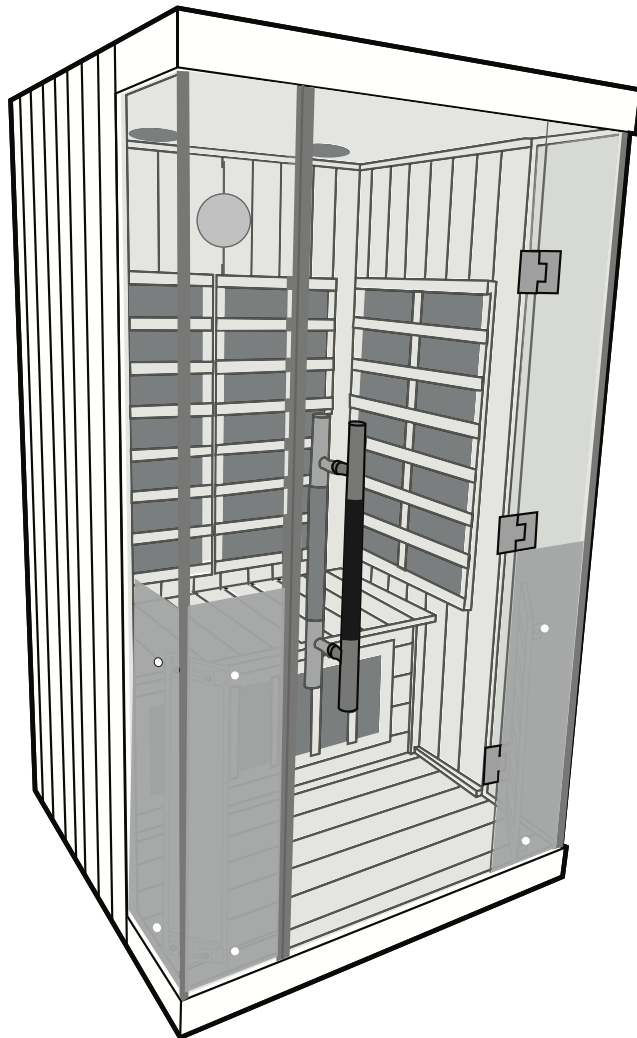

# Using Your Sauna Control Panel

## USING YOUR INFRARED SAUNA

Unlike a traditional sauna, infrared heats the body directly. Air temperature in the sauna is not as important as the type and quality of the infrared being received. We recommend the following protocol:

- a. Turn the sauna on for 10 minutes to allow the heaters to come up to optimal temperature and for the cabin to warm to a comfortable temperature.
- b. When you enter the sauna, set the time to the desired session time and turn the thermostat up to 150°F / 65°C. This will keep the heaters on the entire time to ensure that you are receiving constant infrared heat. **During a 30 minute sauna session, the air temperature will reach between 115-125F / 46-51C depending on the starting ambient air temperature.**
- c. Sit back and relax. Enjoy your sauna session.

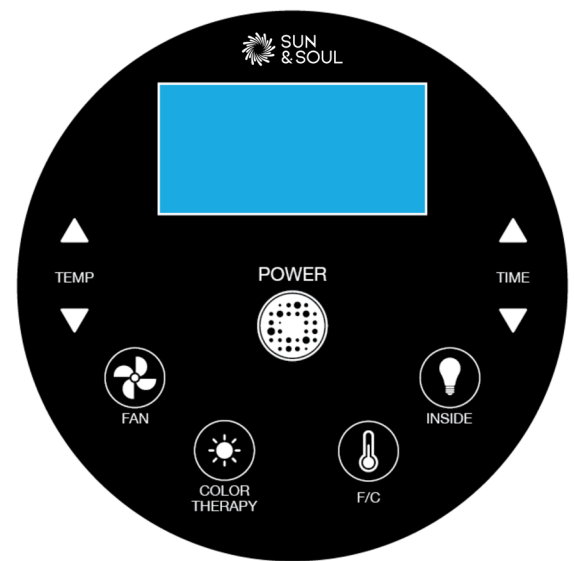

### System On/Off

- 1) Press the "POWER" button once to turn on the sauna.
- 2) Your session will automatically end after the programmed timer expires.
- 3) Press the "POWER" button at any time turn the sauna off.

### Sauna Session Time

You can set the duration of your sauna session for a maximum of 60 minutes. Press the TIME UP or TIME DOWN arrows to increase or decrease your desired sauna session time in 5 minute increments. When you have reached your desired time, release the button.

### Controlling the Set Temperature

You can program your sauna for a maximum temperature of 158F (70°C). Press the TEMP UP/DOWN arrows to set the desired temperature. When the display shows your desired temperature, release the buttons. Press either the TEMP UP or TEMP DOWN buttons during your sauna session to manually control the desired cabin temperature.

# Using Your Sauna Control Panel

## USING YOUR INFRARED SAUNA

### Inside Light

1. Press the button labelled "INSIDE" to turn on or off the Interior light.

### Audio System

Your Sun and Soul sauna is equipped with stereo speakers that can be accessed by either Bluetooth or through the Aux 3.5 mm connection located on the keypad.

1. Your Sun and Soul sauna is Bluetooth ready. To connect audio via Bluetooth:
  - A) Open your Bluetooth enabled phone, tablet or computer and search for surrounding Bluetooth devices to find a device called **Infrared Sauna**. The pairing code for this device is **0000**.

### Chromotherapy

Different colors have different wavelengths and can help balance energy for the mind and body. Your sauna is equipped with a chromotherapy feature.

The chromotherapy light is controlled by pressing the COLOR button on the keypad.

Pressing the button once will activate auto mode automatically cycling between colors changing every 8 seconds.

You can also manually change the colors:

1. Press the "Color" button 2 times to change to **GREEN**
2. Press the "Color" button 3 times to change to **RED**
3. Press the "Color" button 4 times to change to **BLUE**
4. Press the "Color" button 5 times to change to **YELLOW**
5. Press the "Color" button 6 times to change to **INDIGO**
6. Press the "Color" button 7 times to change to **VIOLET**
7. Press the "Color" button 8 times to turn off the Color Light Therapy.





